

IMPORTANT: EG 1-2-3 PRODUCT INFORMATION

- The EG 1-2-3 Hidden Fastener has been designed to work specifically and exclusively with the EverGrain 1" x 6" and 2" x 6" decking profiles. Usage of the fastener with any other product has not been tested and is not recommended.
- Make safety of the workplace the prime consideration. Always wear the proper protective clothing and safety equipment.
- Framing supports should be straight and level with each other to ensure proper installation and an even surface.
- EG 1-2-3 Hidden Fasteners must be installed in accordance with the installation instructions. Deviation from these instructions may result in unsatisfactory performance and may exclude coverage of your EG 1-2-3 Hidden Fastener under the limited warranty.

TOOLS & MATERIALS NEEDED

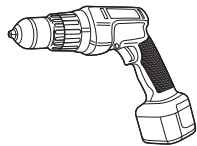

Power screw gun with ratcheting torque setting

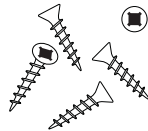

3/4" BOARD Screws (included in packaging)

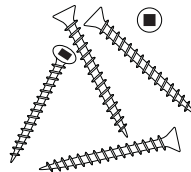

1 1/2" JOIST Screws (included in packaging)

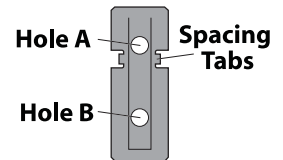

EG 1-2-3 Fasteners (included in packaging)

STEP 1. INSTALLING FIRST FASTENERS

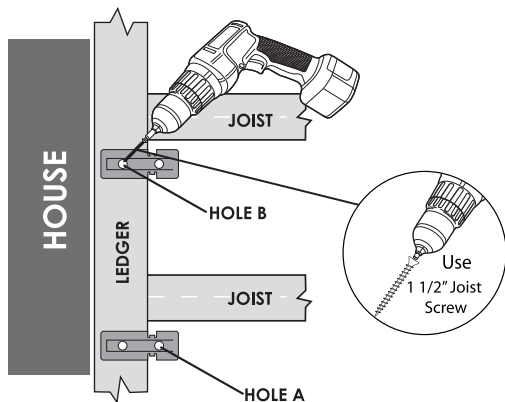

Start installation at the house and work toward the outer edge of the deck. Start by attaching a fastener to the ledger board with spacing tabs pointing downward. Use a joist screw through hole B while allowing hole A to extend over the ledger board as shown. (These will be affixed at a later step.)

STEP 3. INSTALLING FIRST BOARD

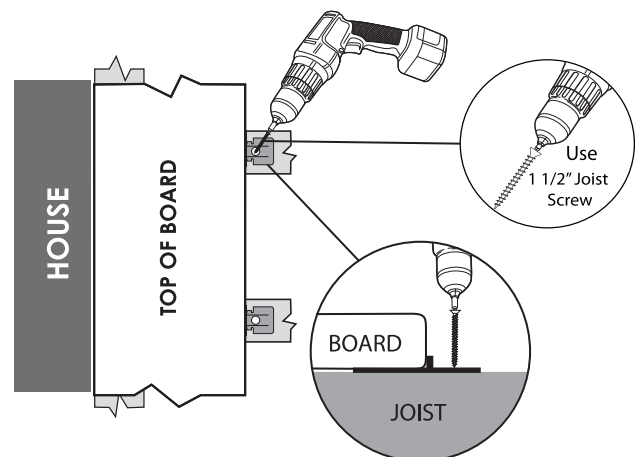

Flip first board back over; align the fastener with framing joist, and install a joist screw through hole A and into the deck frame.

STEP 2. POSITION FASTENERS

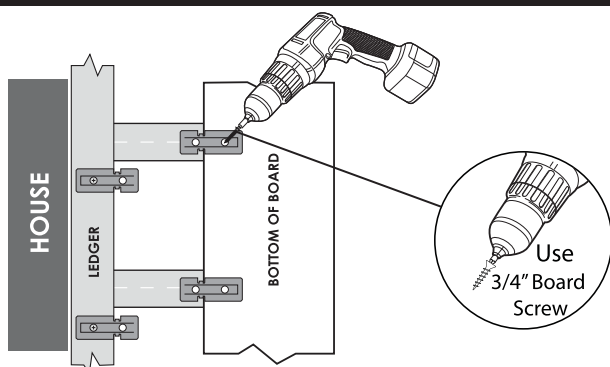

Place first deck board on frame joists in the location where it will be installed. Once in position, flip board over being careful not to move the board side to side from position. Install with board screws to the deck board directly above each joist. Make sure spacing tabs are pointing downward.

CAUTION: Use low torque setting to avoid spinout.

STEP 4. COMPLETING INSTALLATION OF FIRST BOARD

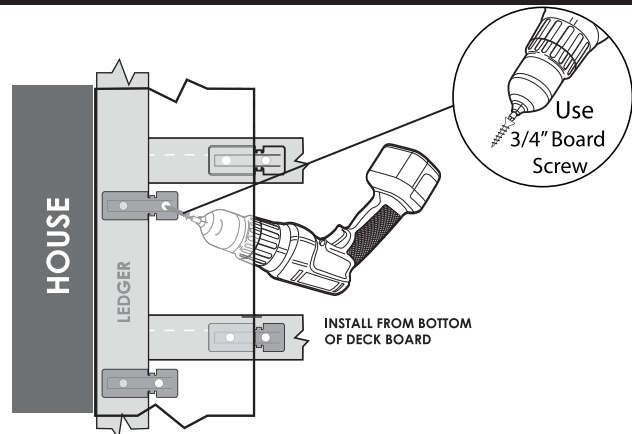

Attach board edge closest to house by installing a board screw through hole A of each fastener up into the bottom of the deck board. (Secure the fasteners installed in Step 1.)

STEP 5. INSTALLING THE NEXT BOARD

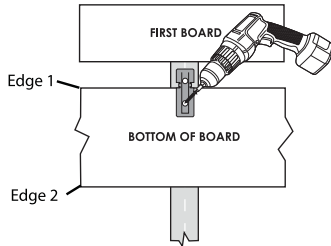

Place deck board in desired location to be installed. Flip deck board over being careful not to move the board side to side from position. Place fastener along Edge 1 (closer to the 1st board) of deck board directly over joist with spacing tabs pointing downward.

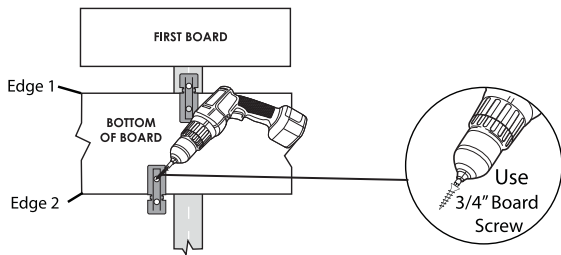

Place another fastener along Edge 2 (direction of install) of board approximately 1" off to the side of joist with spacing tabs pointing downward.

Secure fasteners to board using board screws through hole B. Repeat this process at every joist along remainder of board.

CAUTION: Use low torque setting to avoid spinout.

STEP 6. POSITION DECKING BOARD

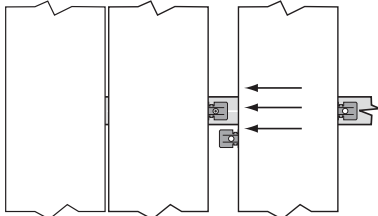

Once fasteners are attached to full board length, flip deck board back over. Position board so fasteners can slide beneath the lead edge of the previous board and exposed fasteners are aligned over the deck joists. Carefully move board into position.

STEP 7. SECURE DECKING BOARD

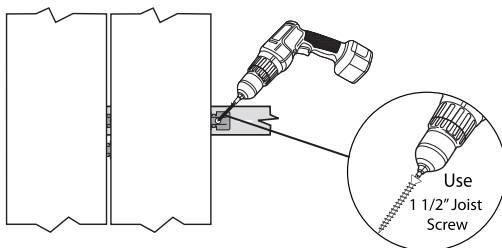

Once proper spacing is confirmed (1/8" spacing is integrated into the fastener), attach deck board to frame using a joist screw through hole A of each fastener.

Repeat steps (5-7) until reaching final deck board.

STEP 8. PREPARING LAST BOARD

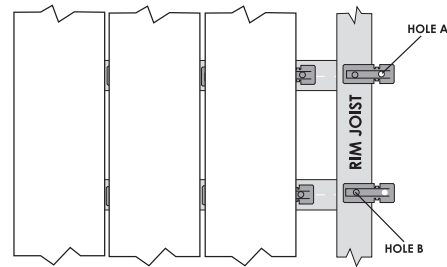

Attach a fastener to the rim joist aligned with each deck joist, with spacing tabs pointing downward. Use a joist screw through hole B while allowing hole A to extend over the outer edge of the rim joist as shown.

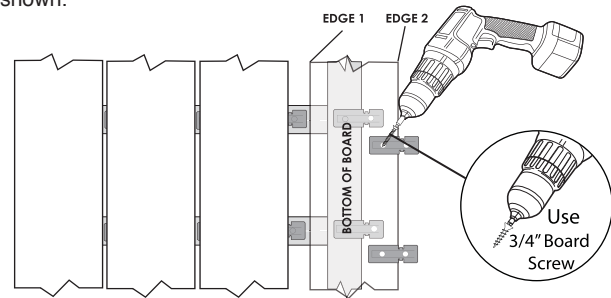

Place last deck board in desired location to be installed. Flip deck board over being careful not to move the board side to side from position. Place fasteners along Edge 2 (direction of install) of board approximately 1" off to the side of the joist with spacing tabs pointing downward.

DO NOT PLACE FASTENERS ON EDGE 1 OF THE BOARD.

Secure fasteners to board using board screws through hole B.

CAUTION: Use low torque setting to avoid spinout.

STEP 9. POSITION AND INSTALL LAST BOARD

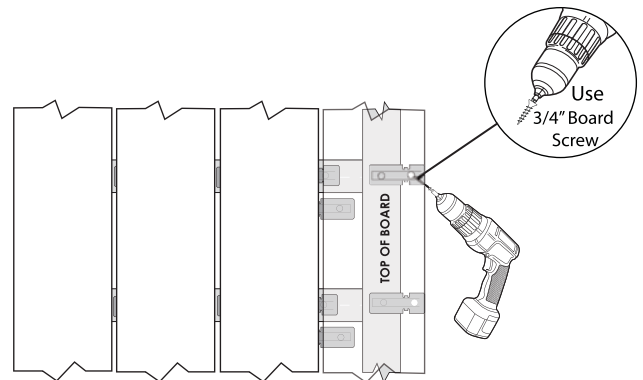

Flip last board back over and position board so fasteners can slide beneath the lead edge of the previous board. Reach under the final board and install board screws up into the bottom of the board through hole A of the fastener attached to rim joist. (Fastener installed in Step 8.)

IMPORTANT EG 1-2-3 PRODUCT INFORMATION

- The EG 1-2-3 Hidden Fastener has been designed to work specifically and exclusively with the EverGrain 1" x 6" and 2" x 6" decking profiles. Usage of the fastener with any other product has not been tested and is not recommended.
- Make safety of the workplace the prime consideration. Always wear the proper protective clothing and safety equipment.
- Framing supports should be straight and level with each other to ensure proper installation and an even surface.
- EG 1-2-3 Hidden Fastener must be installed in accordance with the installation instructions. Deviation from these instructions may result in unsatisfactory performance and may exclude coverage of your EG 1-2-3 Hidden Fastener under the limited warranty.

TOOLS & MATERIALS NEEDED

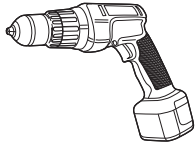

Power screw gun with ratcheting torque setting



Pencil



1/8" Drill Bit

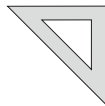

Square (Optional)

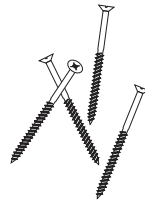

2 1/2" Deck Screws (not included)



3/4" BOARD Screws (included in packaging)

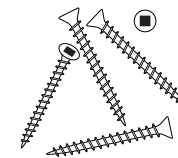

1 1/2" JOIST Screws (included in packaging)

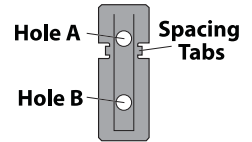

EG 1-2-3 Fasteners (included in packaging)

STEP 1. PREPARING TO INSTALL

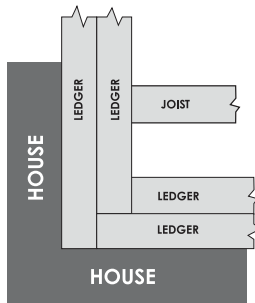

Any framing up against a structure should be doubled for proper installation. Always start installation in the structure corner and work toward the outer edge of deck. Framing blocks can be added for existing frames.

STEP 2. POSITION FIRST FASTENERS

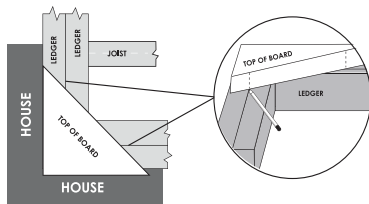

Place first corner board in position where it will be installed. Vertically mark the decking board at framing seams as shown.

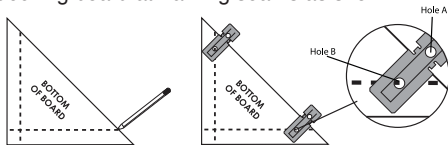

Flip board over, and extend the vertical mark along the bottom of the board. Hook fasteners on the edge of the board with spacing tabs tight against board edge and pointing downward. Slide fasteners along edge until the pencil mark runs through the center of hole B while allowing hole A to extend over the board. Secure fasteners on both ends of board using a board screw.

CAUTION: Use low torque setting to avoid spinout.

STEP 3. COMPLETING INSTALLATION OF FIRST BOARD

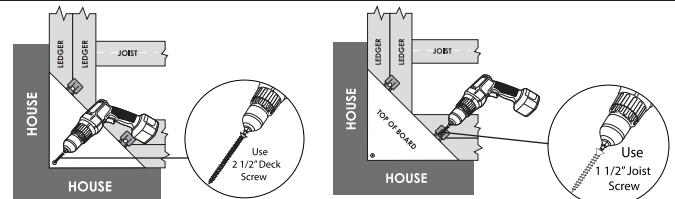

Flip first board back over; pre-drill a 1/8" hole in the corner of the board that will be against the wall. Attach board to the frame using a color coordinating decking screw (not supplied).

To finish securing the board, install a joist screw through each fastener and into the deck frame.

STEP 4. INSTALLING THE NEXT BOARD

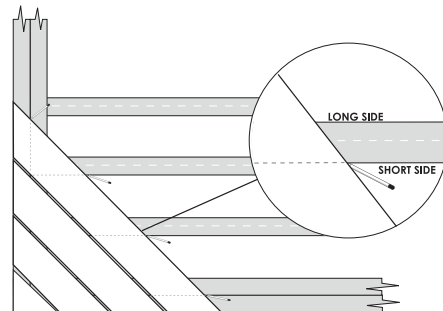

Place next board in desired position. Mark entire board from underneath with a pencil on the *short side of each joist.

* **Short Side of Joist:** As a deck board crosses a joist or ledger at a 45°, one edge of the joist appears shorter than the other.

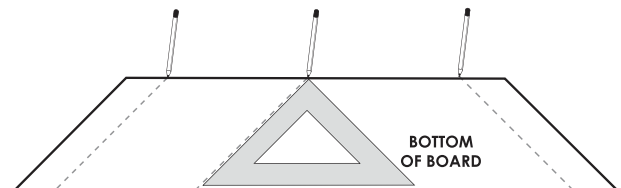

Flip deck board over. If needed use a 45° square to continue the angle completely across the board.

STEP 4. INSTALLING THE NEXT BOARD - continued

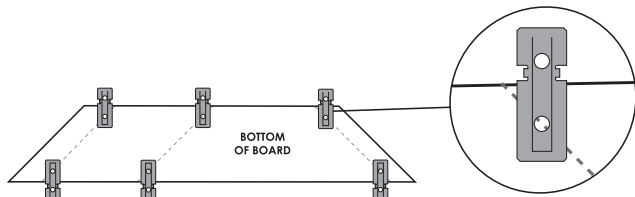

Place fastener tight against board edge with spacing tabs pointing downward. Slide fastener along edge of board until the pencil mark runs through the center of hole B while allowing hole A to extend over the board. Secure fasteners on both sides of board using board screws.

CAUTION: Use low torque setting to avoid spinout.

STEP 7. INSTALLING FINAL BOARD

Depending on your deck design, completion of your 45° installation can be achieved by following Steps 1 and 2.

LIMITED WARRANTY

TAMKO Building Products, Inc. provides a 15-year limited warranty for the EG 1-2-3 Hidden Fastener installed in accordance with these written instructions. For a copy of the limited warranty see your EverGrain Dealer or visit evergrain.com. Returns of or claims for the EG 1-2-3 Hidden Fastener due to any condition that was clearly apparent prior to application/fastening of product, will not be considered after the fasteners have been applied/fastened to deck board, sub-structure, joist, etc.

STEP 5. POSITION DECKING BOARD

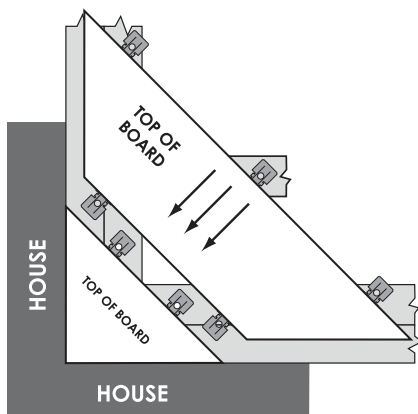

Once fasteners are attached, flip deck board back over. Position board so fasteners slide beneath the lead edge of the previous board.

STEP 6. SECURE DECKING BOARD

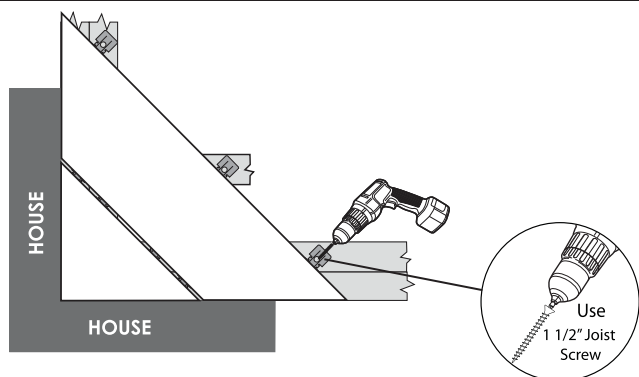

Once proper spacing is confirmed (1/8" spacing is integrated into the fastener), attach deck board to frame using a joist screw through hole A of each fastener.

Repeat steps 4-6 until reaching final deck board.

TAMKO Building Products, Inc.

P.O. Box 1404, Joplin, Missouri 64802

- Technical Services: 800-641-4691
- Warranty Services: 800-441-7190
- Customer Service: 800-253-1401

These application instructions were current at the time of printing. To obtain a copy of the most current version of the application instructions, visit us online at evergrain.com or call us at 800-641-4691.

